

NBS 82 for CNC Sharpening of Saw Blades & Band Saw Blades

The next generation of CNC sharpening machines, the NBS 82 brings the joy of sharpening process - higher quality sharpening results, operator safety and remote access support via internet - backup programs; software updates; via PC or smart phone access to machine display; remote service support; integration into the production process and gathering technological data, etc.

The machine is ideal for the sharpening of stellite, CV, bimetal and carbide-tipped saw blades up to 100 mm wide. It operates with ceramic, CBN or diamond grinding wheels using water cooling. Driven diamond dressing wheel with automatic cycle is installed as a standard equipment in order to keep the shape of ceramic stone clean and consistent. Thanks to this, the stable and consistent tooth shape of the sharpened blade is ensured.

The grinding cycle is controlled via CNC servo motors; with the result that the saw tooth dynamics remain consistent. NBS 82 incorporates a coolant reservoir and spray system which helps to keep the saw blades cool during grinding.

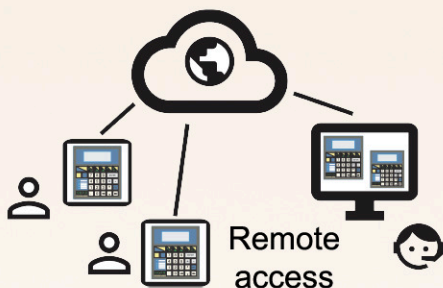

Constant pitch sharpening



Variable pitch sharpening



NBS 82 for CNC Sharpening of Saw Blades & Band Saw Blades

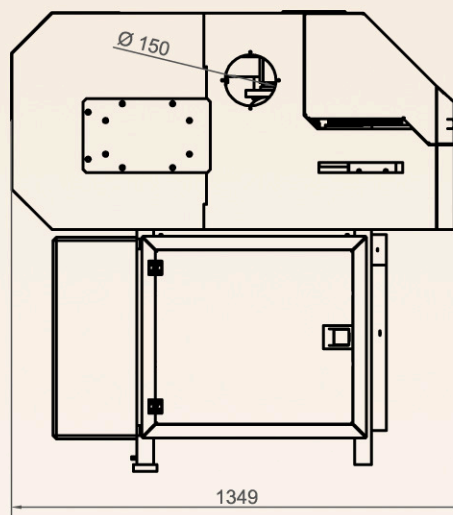
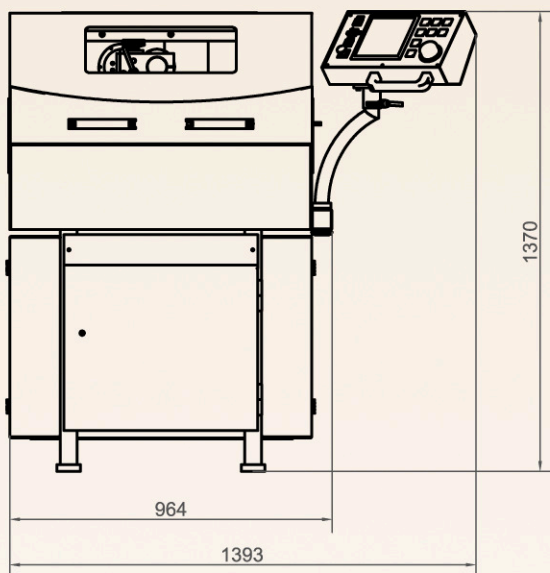
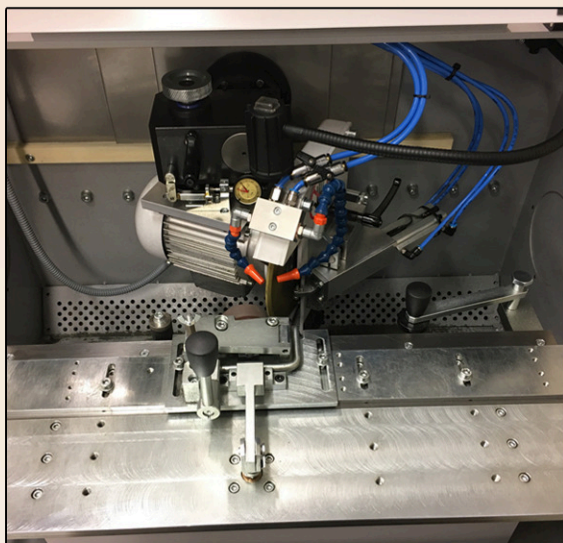

Tooth Designer



Free applications for your NBS machine



Remote Display

Technical specification

Saw blades length	200 – 1000 mm
Thickness of body	0.5 – 3.0 mm
Tooth pitch	3 – 75 mm
Tooth depth – max.	15 mm
Face angles	0° – 30°
Back tooth angles	0° – 20°
Working speed	100 – 5000 mm/min.
Grinding wheel max. speed via frequency inverter	50 m/s
Grinding wheel diameter	250 mm
Diameter of the shaft of grinding wheel	32 mm
Breadth of the grinding wheel	6 – 10 mm
Compressed air – min.	6 bar
Compressed air volume	approx. 2 m ³ /h

Motor specifications

Spindle motor with frequency inverter	0.55 kW
Servo motor Z	0.40 kW
Servo motor X	0.40 kW
Pump motor	0.155 kW
Dressing wheel motor*	0.060 kW

Machine dimensions

Width	1393 mm
Depth	1349 mm
Height	1370 mm
Weight	600 kg